

LINSEIS

T H E R M A L A N A L Y S I S

**LIGHT
FLASH
ANALYSIS**

LFA 500

LT

500

1000

1250



Since 1957 LINSEIS Corporation has been delivering outstanding service, know how and leading innovative products in the field of thermal analysis and thermo physical properties.

Customer satisfaction, innovation, flexibility and high quality are what LINSEIS represents. Thanks to these fundamentals, our company enjoys an exceptional reputation among the leading scientific and industrial organizations. LINSEIS has been offering highly innovative benchmark products for many years.

The LINSEIS business unit of thermal analysis is involved in the complete range of thermo analytical equipment for R&D as well as quality control. We support applications in sectors such as polymers, chemical industry, inorganic building materials and environmental analytics. In addition, thermo physical properties of solids, liquids and melts can be analyzed.

LINSEIS provides technological leadership. We develop and manufacture thermo analytic and thermo physical testing equipment to the highest standards and precision. Due to our innovative drive and precision, we are a leading manufacturer of thermal Analysis equipment.

The development of thermo analytical testing machines requires significant research and a high degree of precision. LINSEIS Corp. invests in this research to the benefit of our customers.



Claus Linseis
Managing Director

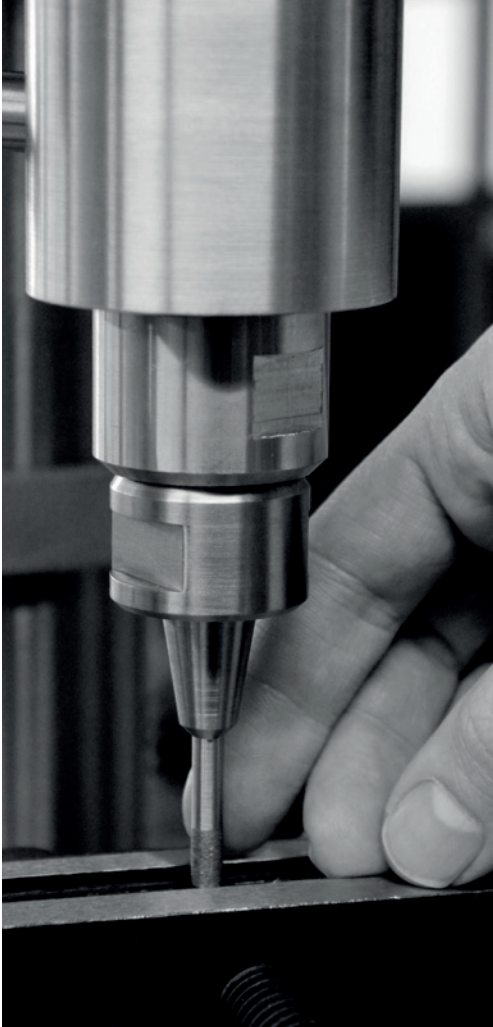

German engineering

The strive for the best due diligence and accountability is part of our DNA. Our history is affected by German engineering and strict quality control.

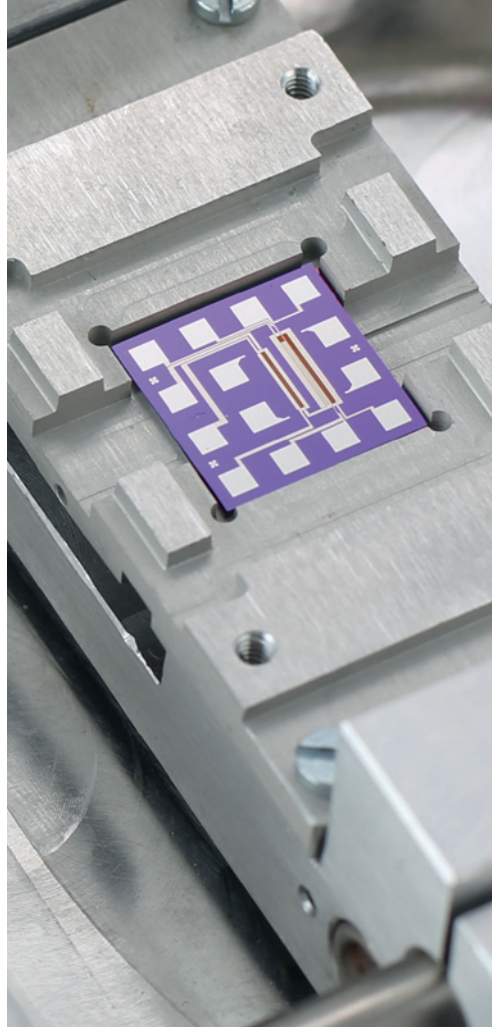

Innovation

We want to deliver the latest and best technology for our customers. LINSEIS continues to innovate and enhance our existing thermal analyzers. Our goal is constantly develop new technologies to enable continued discovery in science.

THE TECHNIQUE



LFA 500/1250

Information about the thermophysical properties of materials and heat transfer optimization of final products is becoming more and more vital for industrial applications. Over the past few decades, the flash method has developed into a commonly used technique for the measurement of the thermal diffusivity and thermal con-

ductivity of various kinds of solids, powders, pastes and liquids. Application areas are electronic packaging, heat sinks, brackets, reactor cooling, heat exchangers, thermal insulators and many others. Trouble-free sample preparation, small required sample dimensions, fast measurement times and high accuracy are only a few of the advantages of this non-contact and non-destructive measurement technique.

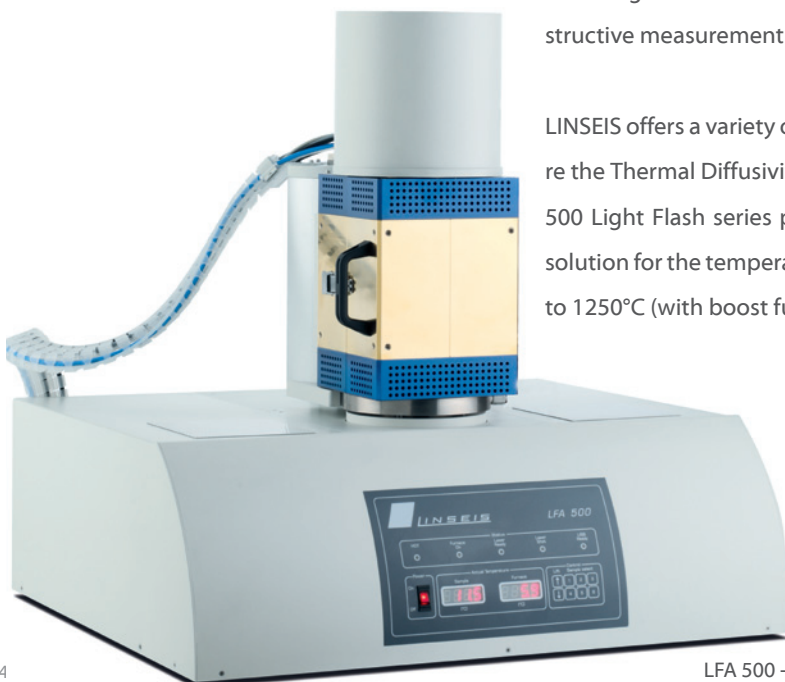

LFA 500 - LT/500//1000

MEASUREMENT CONCEPT

The sample is either positioned on a sample robot, which is surrounded by a furnace (LFA 500-LT/500/1000) or within one out of five microheaters located on a moveable linear stage (LFA 500/1250). For the measurement, the furnace is held at a predetermined temperature and a programmable energy pulse irradiates the back side of the sample, resulting in a homogeneous temperature rise at the sample surface.

The resulting temperature rise of the surface of the sample is measured by a very sensitive high speed IR detector. Both, thermal diffusivity and specific heat can be determined from the temperature vs. time data. If the density (ρ) is identified, the thermal conductivity can be calculated:

$$\lambda(T) = \alpha(T) \cdot c_p(T) \cdot \rho(T)$$

λ =Thermal Conductivity [W/mK]
 α =Thermal Diffusivity [mm²/s]
 c_p =Specific Heat [J/g·K]
 ρ =Density [g/cm³]

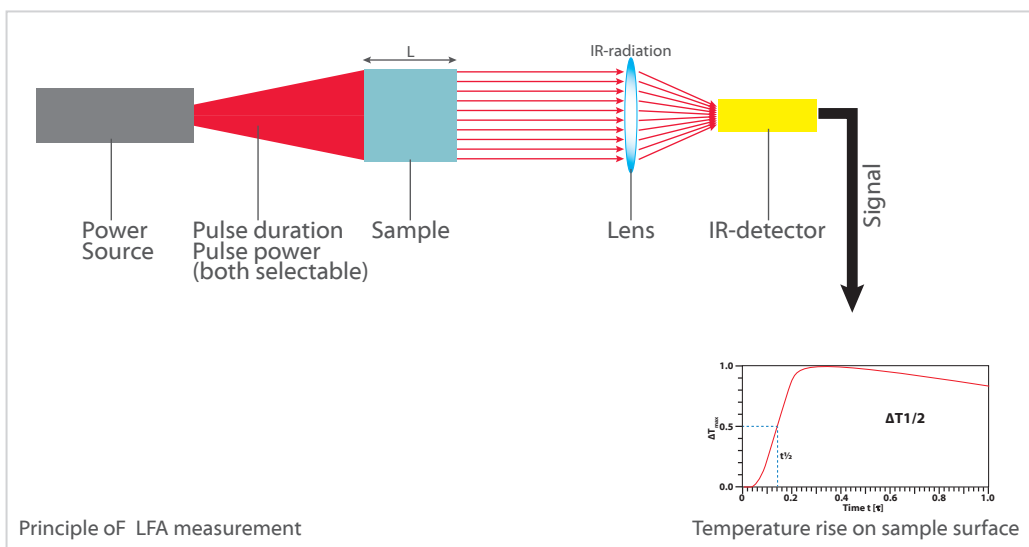

Calculation of thermal diffusivity

- Determine the baseline and maximum rise to give the temperature difference, ΔT_{\max}
- Determine the time required from the initiation of the pulse for the rear face temperature to reach $\Delta T_{1/2}$. This is the half time, $t_{1/2}$.
- Calculate the thermal diffusivity, α , from the specimen thickness, samples height L squared and the halftime $t_{1/2}$, as follows:

$$\alpha = 0.13879 L^2 / t_{1/2}$$

L =Sample height
 $t_{1/2}$ =Half time rise
 α =Thermal Diffusivity

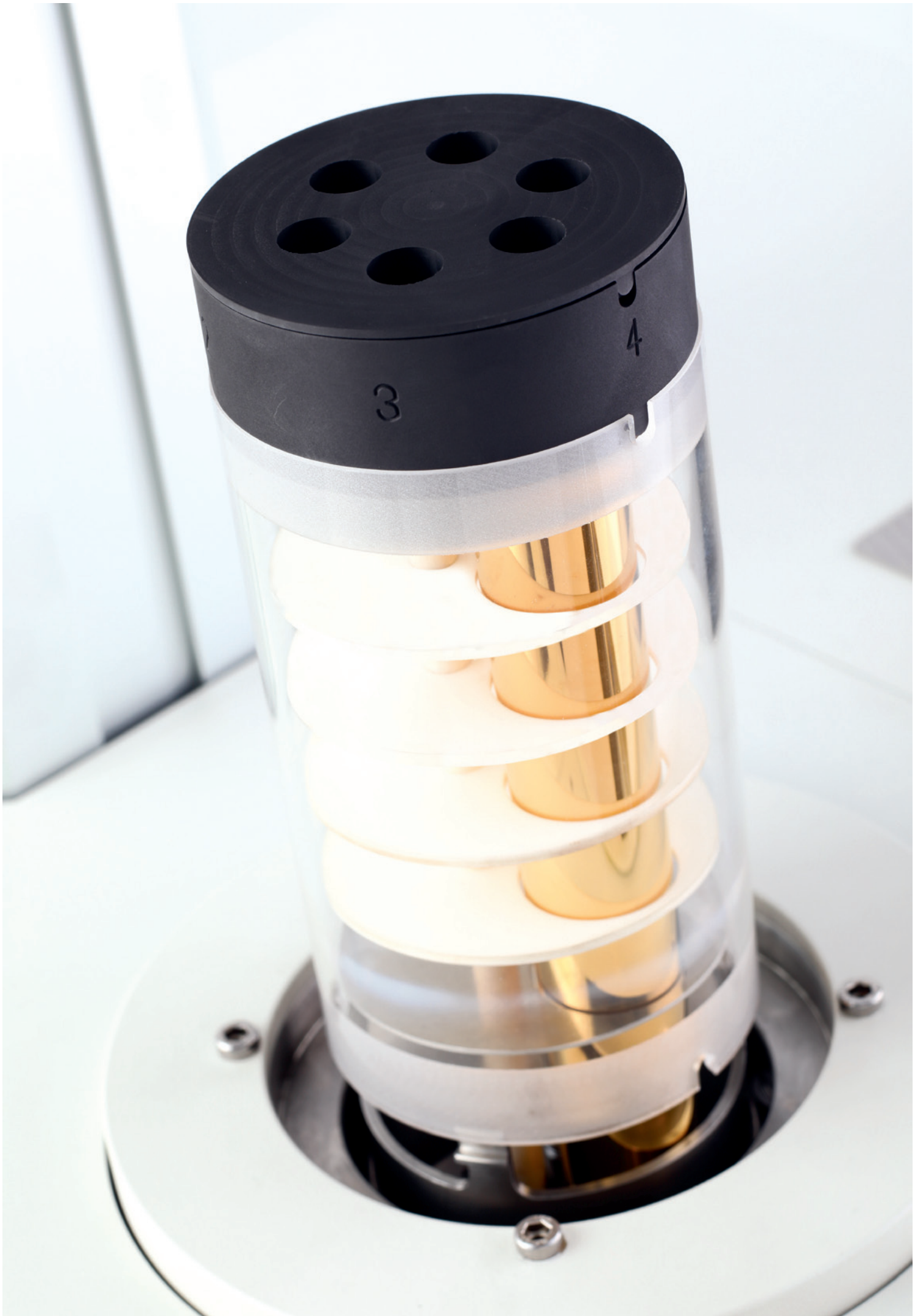

HIGH ENERGY PULSE SOURCE

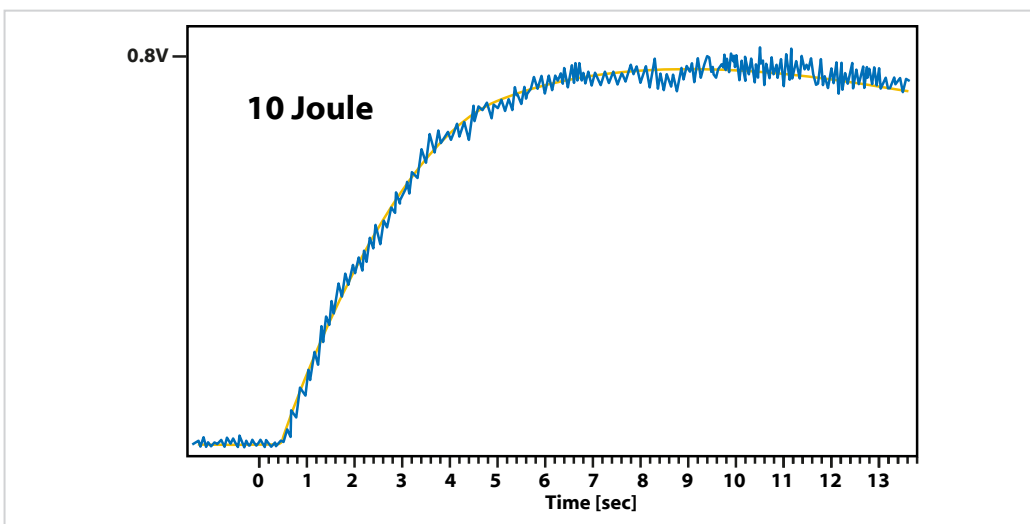
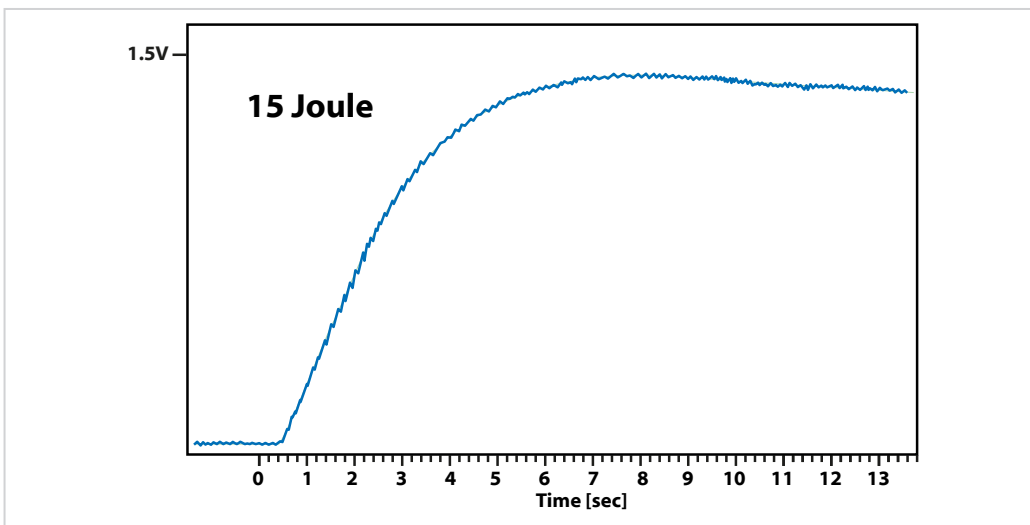

LINSEIS high performance flash system offers up to 15 Joule pulse energy. This superior performance now enables the precise characterization of samples with low thermal conductivity and unfavorable geometries (diameter / height ratio).

The example illustrates a 4mm thick Polymer sample analyzed with a 10 Joule and a 15 Joule Flash system. The superior signal to noise ratio of the high performance 15J Flash system clearly illustrates the advantage of providing 50% more energy.

SYSTEM DESIGN

The vertical arrangement with sensor on top, sample in the middle and Light Flash source on the bottom ensure easy handling and best possible measurement results. The pulse energy is adjustable in the range of 0.02 to 15 Joule/pulse.

In addition the pulse duration can be adjusted from 20 μs to 2000 μs . Due to this flexibility all kinds of demanding samples (thin film or ultra-low thermal conductivity) can be analyzed.

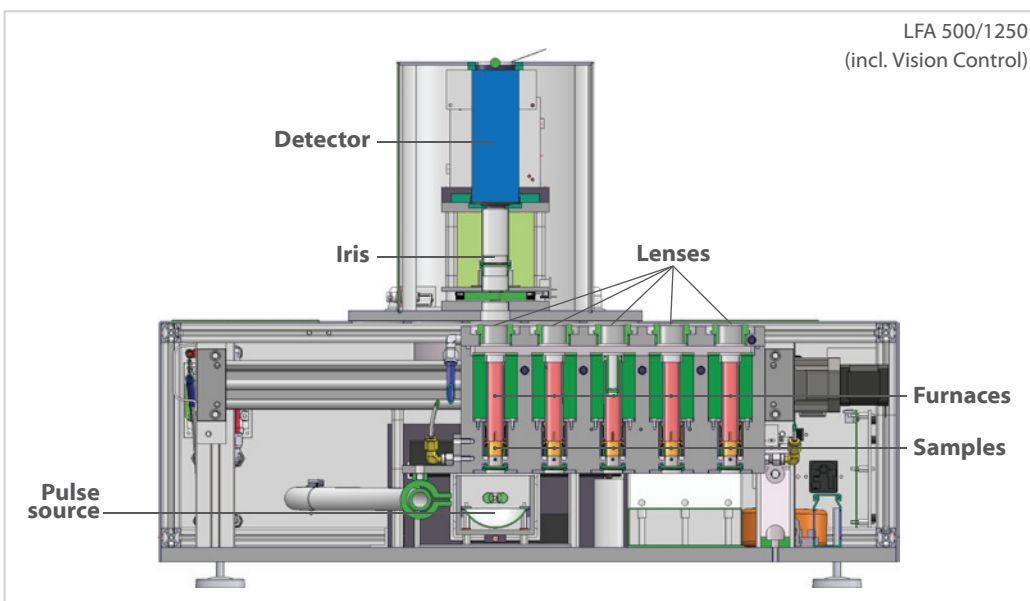
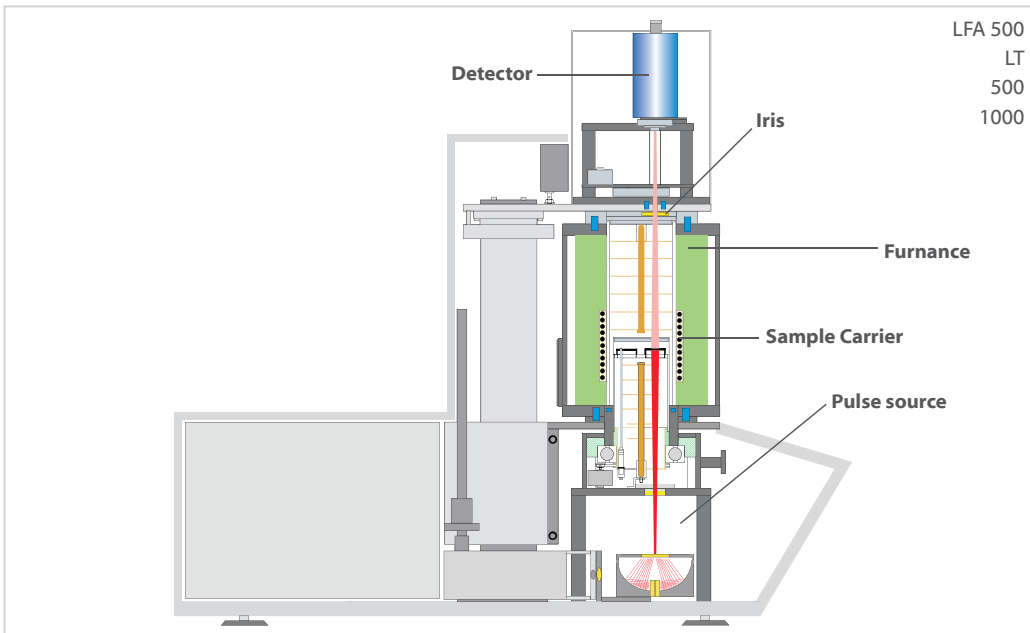

ABSOLUTE METHOD

The method used is an absolute measurement technique (for thermal diffusivity), hence there is no need to calibrate the system. The LFA 500

Light Flash operate in agreement with national and international standards, such as ASTM E-1461, DIN 30905 and DIN EN 821.

FUTURE UPGRADES

LINSEIS is offering an unparalleled modular system design. It is possible to upgrade the temperature range (exchangeable furnaces) and the detector (InSb/MCT). This enables the user to

start with a cost effective solution and upgrade the system whenever the budget allows or the measurement task requires it.

DETECTORS

The system can be either equipped with an InSb detector or with a MCT detector , covering the complete temperature range from sub-ambient up to 1000°C. Both are easily user exchangeable.

An automatic LN₂ refilling accessory with Dewar can be ordered for prolonged measurement cycles.

ENVIRONMENTAL OPTIONS

The instrument can be operated under defined atmospheric conditions. It is either possible to attach a vacuum pump, in order to minimize

heat loss effects or to attach an additional gas dosing systems to measure under specific atmospheres.

VISION CONTROL

LFA500/1250

The vision control feature provides best signal quality for any sample dimension and is available for the LFA 500/1250. The optimization ensures superior signal quality for big and small

samples. In addition the arrangement overcomes positioning accuracy problems with existing zoom lens systems by ensuring best possible Specific Heat determination capabilities.

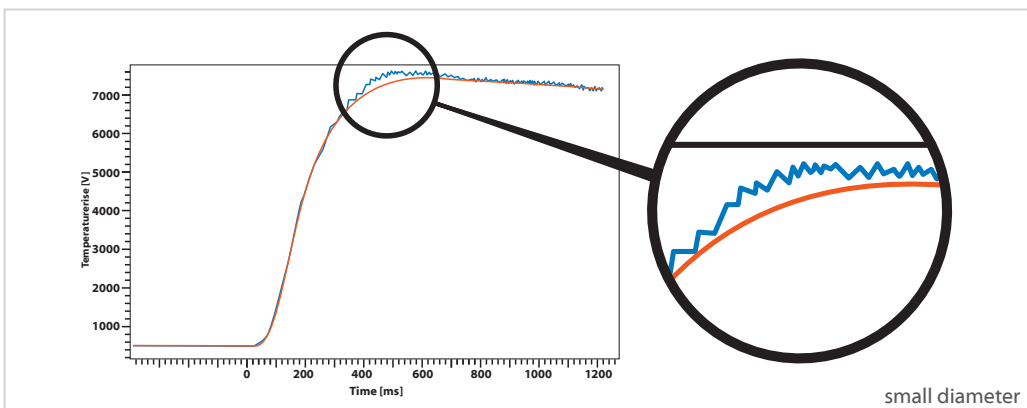
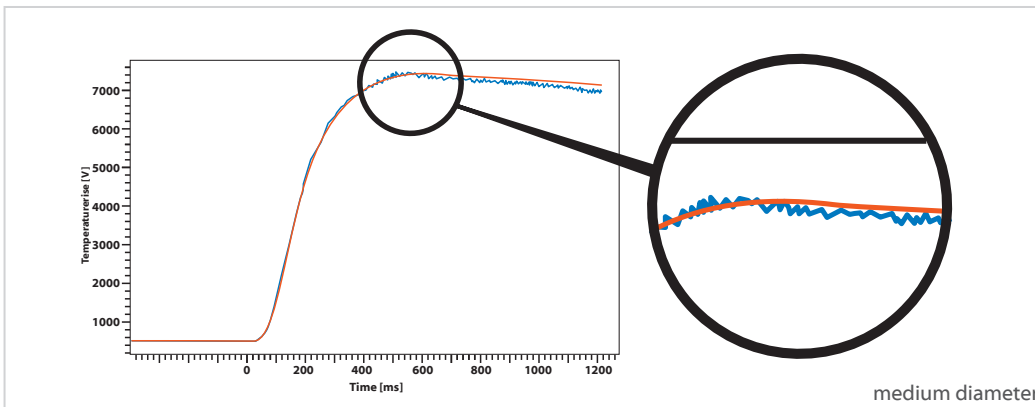
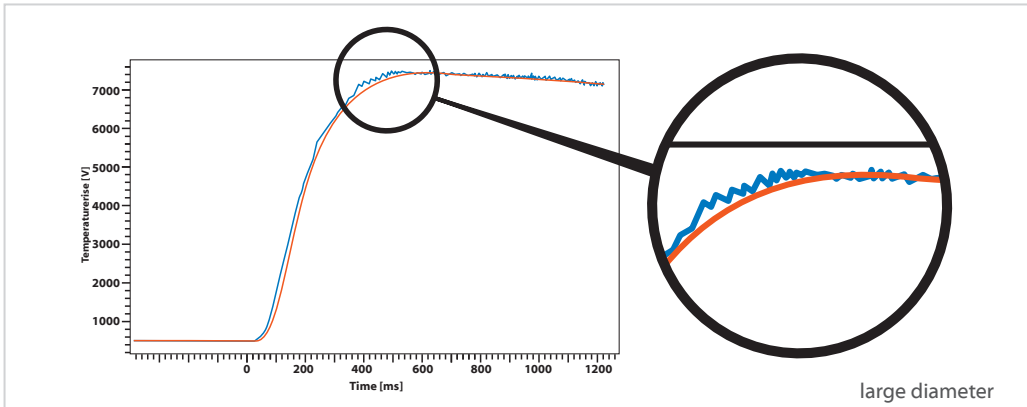

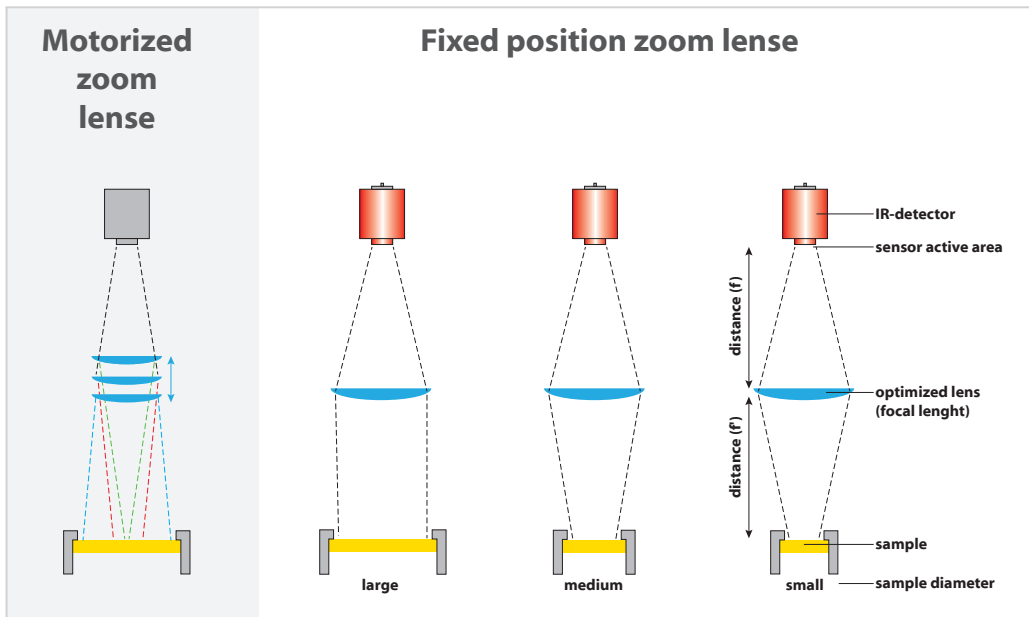

Measurement principle

In a Flash system the signal quality depends on the amount of radiation of the sample which hits the surface of the infrared detector. Normally the active surface of the detector is limited (e.g. 2x2mm) compared to a sample diameter of (3 ... 25.4mm). For this reason, an optimized arrangement of IR-detector, lens and sample is used to improve the imaged sample surface. The measurement spot on the sample should be as large as possible, but it should not exceed the sample. Any exceeding of the spot can generate additional noise on the signal.

Vision Control

LINSEIS „Vision Control“ fixed position zoom lens arrangement ensures a perfect detection spot for different sample geometries, using the best possible configuration of lens (focal length) and sample size. In addition the fixed position lens arrangement, compared to a motor driven „Zoom“ objective, ensures a superior position accuracy. As a motor driven lens always has a scaling error. In order to gain best possible Specific Heat data by comparative method, a perfect reproducible position of the lens is inevitable.

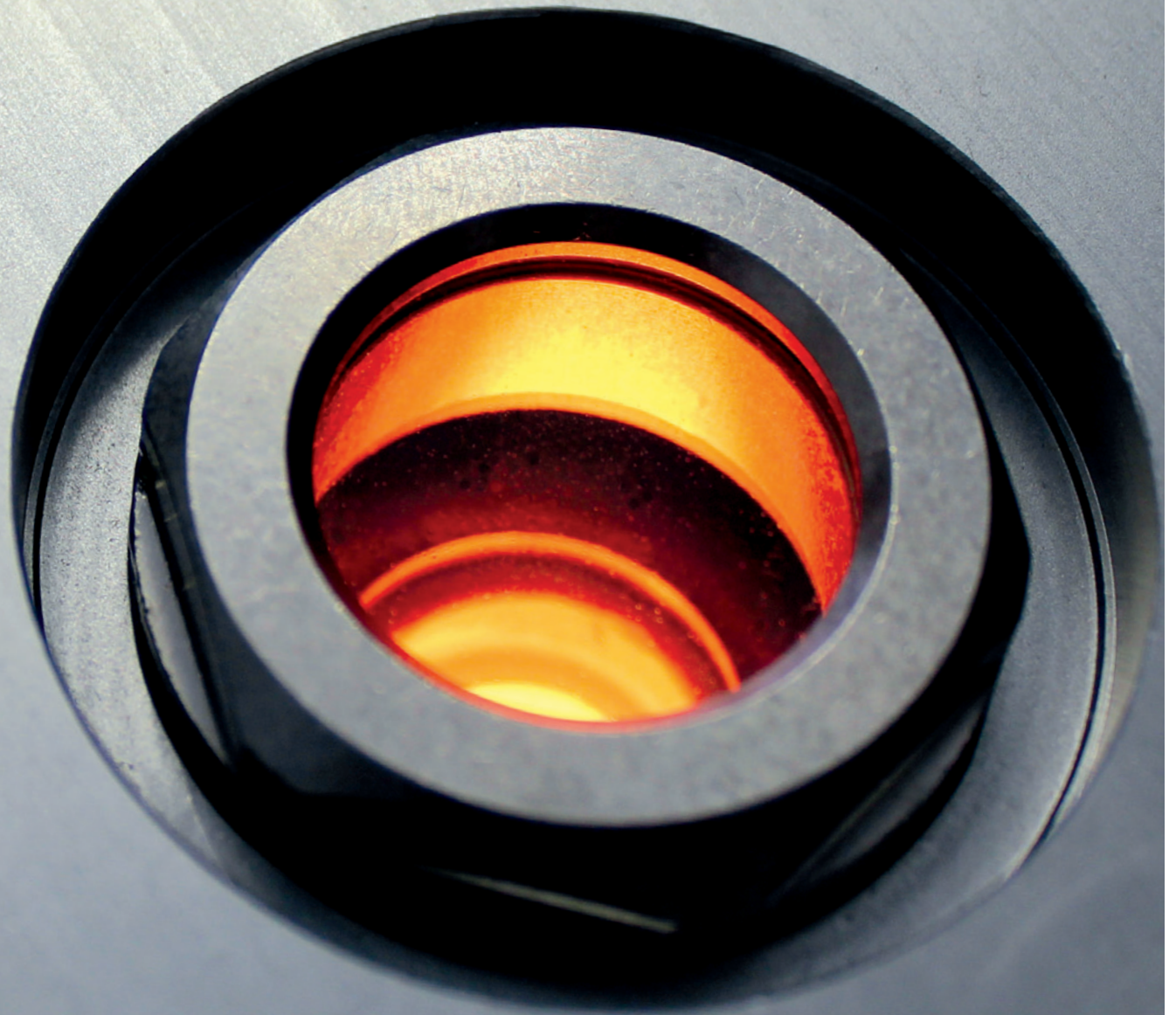
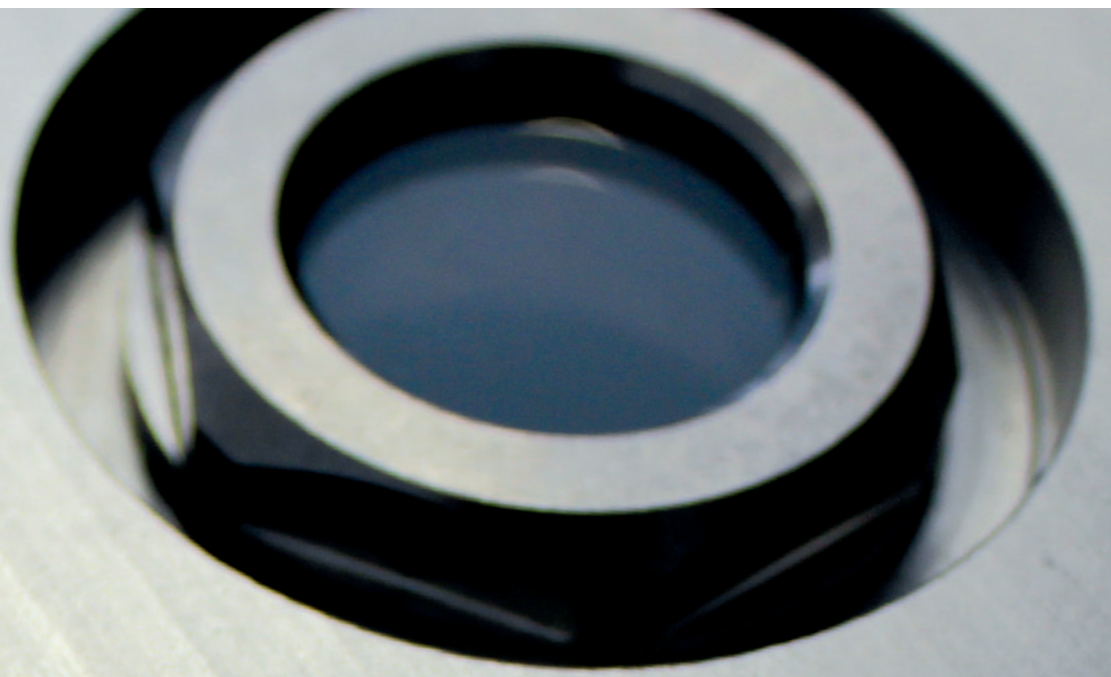

HIGH SPEED INFRARED FURNACE OR MICRO-HEATER

The LFA unit is either equipped with a high speed infrared furnace (LFA 500 - 500/1000) or with an advanced microheater (LFA 500/1250). This technology enables unmatched heating and cooling speed of the system, providing

highest sample throughput. In addition the Infrared/microheater technology provides unmatched temperature control, homogeneity and precision.

Because Time Matters

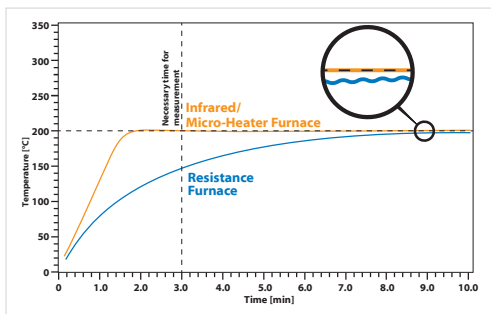

Time to reach the temperature stability comparison. A high speed IR-micro-heater furnace reaches the set temperature much faster and delivers a superior isothermal temperature stability

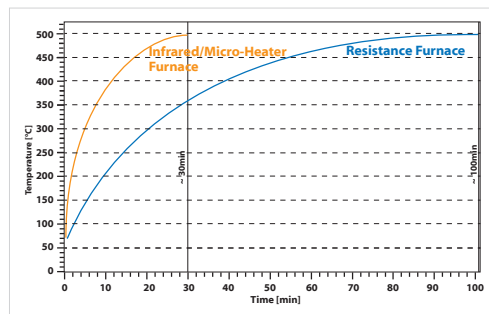

Elapsed time for temperature dependent measurement run. Infrared/micro-heater technology drastically increases sample throughput/productivity.

UNMATCHED SAMPLE THROUGHPUT

Highest throughput in the market. The combination of sample robot and infrared furnace allows unbeaten measurement turnaround

time. A typical measurement for up to 18 samples takes only a few hours.

Sample carriers

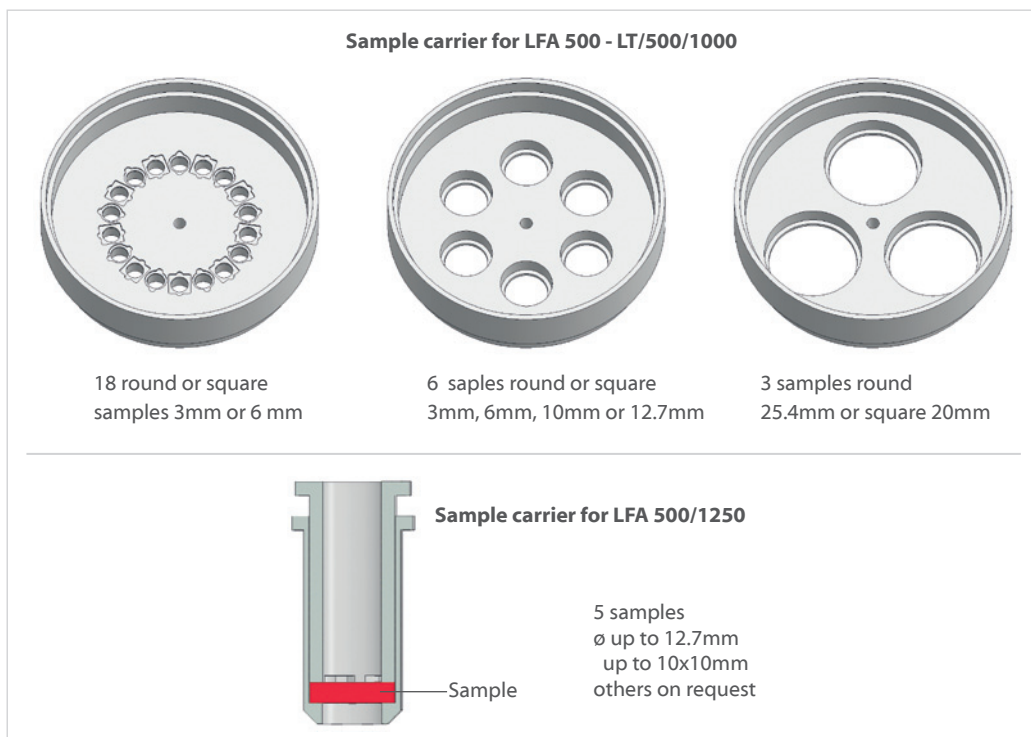

Sample holder

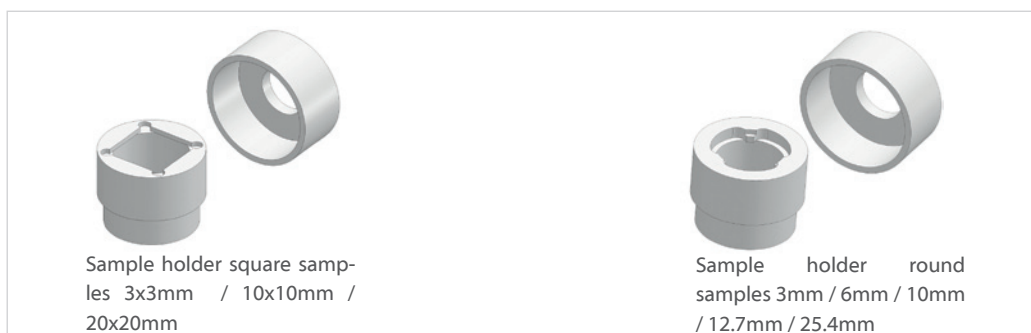

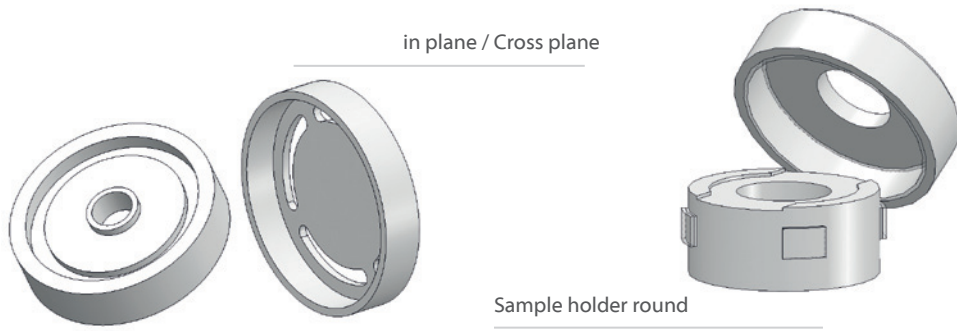
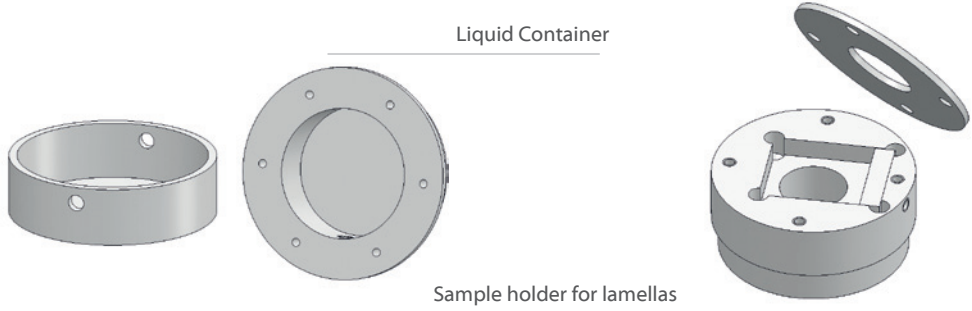

Sample holder for liquids and pastes

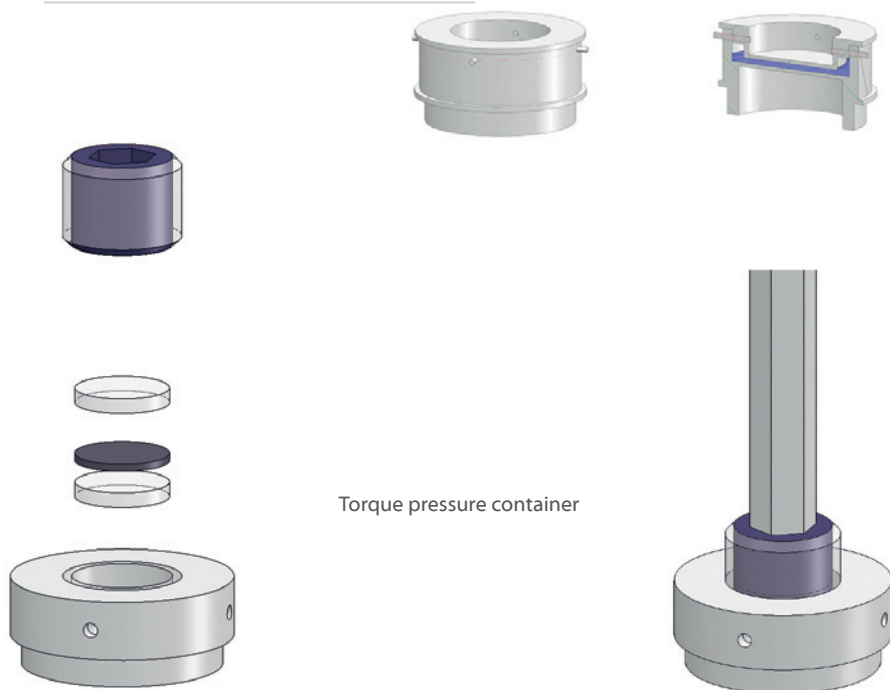

SOFTWARE

- Fully compatible MS®Windows™ software
- Data security in case of power failure
- Safety Features (Thermocouple break protection, power failure, etc.)
- Online and offline Evaluation of current measurement
- Curve comparison
- Storage and export of evaluations
- Export and import of data in ASCII format
- Data export to MS Excel
- Multi - method analysis (DIL, STA, LSR, LZT)
- Programmable gas control

Measurement Software

- Easy and user-friendly data input for temperature segments, gases etc.
- Controllable sample robot
- Software automatically displays corrected measurements after the energy pulse
- Fully automated measurement procedure for multi sample measurements

Evaluation Software

- Automatic or manual input of related measurement data: (density), Cp (Specific Heat)
- Model wizard for selection of appropriate model:

Evaluation Models

- Dusza combined model
- Cowan
- 2/3 layer models
- Parker
- Cowan5
- Cowan 10
- Azumi
- Clark-Taylor
- Degiovanni
- Finite pulse correction
- Heat loss correction
- Baseline correction
- Multilayer model
- Determination of contact resistance

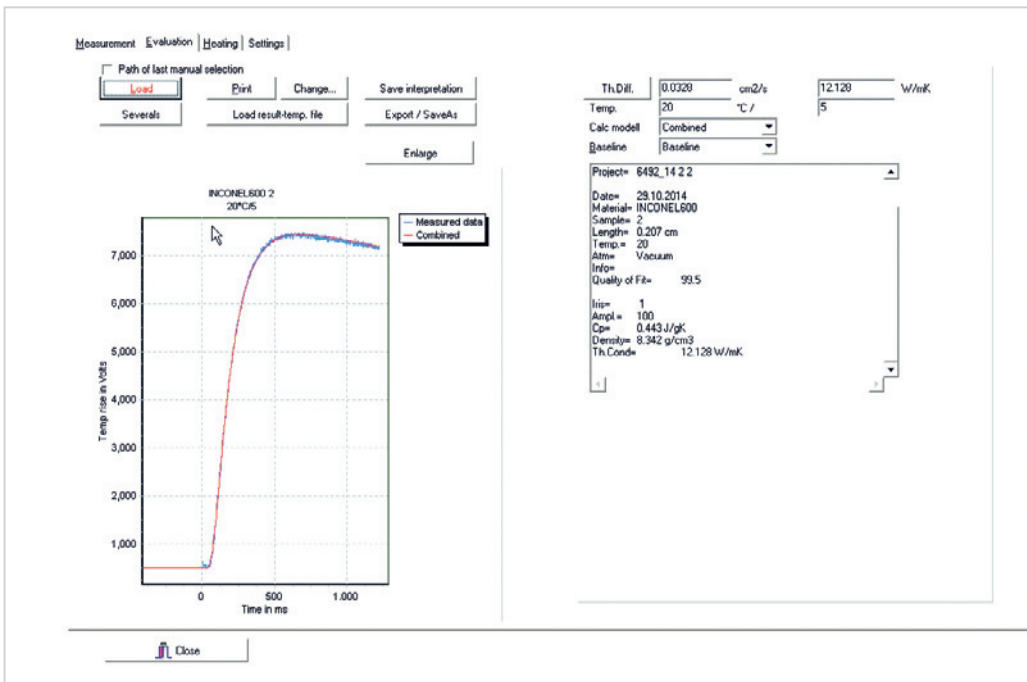

Cp (Specific Heat) determination by comparative method

To calculate the specific heat capacity, the maximum of the temperature raise in the sample is compared to the maximum of the temperature raise of a reference sample. Both, the unknown and the reference sample are measured under the same conditions in a single run, using the sample robot. So, the energy of the laser pulse and the sensitivity of the infrared detector are the same for both measurements. The temperature raise in the sample can be calculated according the following equation:

$$\Delta T = \frac{E}{m \cdot cp}$$

ΔT = Raise in temperature [K]

E = Energy [J]

m = Weight [g]

cp = Heat capacity [$\frac{J}{gK}$]

Since the energy is the same for sample and reference, the Cp of the sample can be calculated according the following equation:

$$cp_{\text{Sample}} = \frac{cp_{\text{Reference}} \cdot \Delta T_{\text{Reference}} \cdot m_{\text{Reference}}}{\Delta T_{\text{Sample}} \cdot m_{\text{Sample}}}$$

To achieve a good accuracy, the absorbability and emissivity of sample and reference must be the same (same coating), and the absolute heat capacity ($cp \cdot \text{Weight}$) of sample and reference must be similar.

DUSZA SOFTWARE COMBINED MODEL

Combined solution of the simultaneous heat loss and finite pulse corrections with the laser flash method

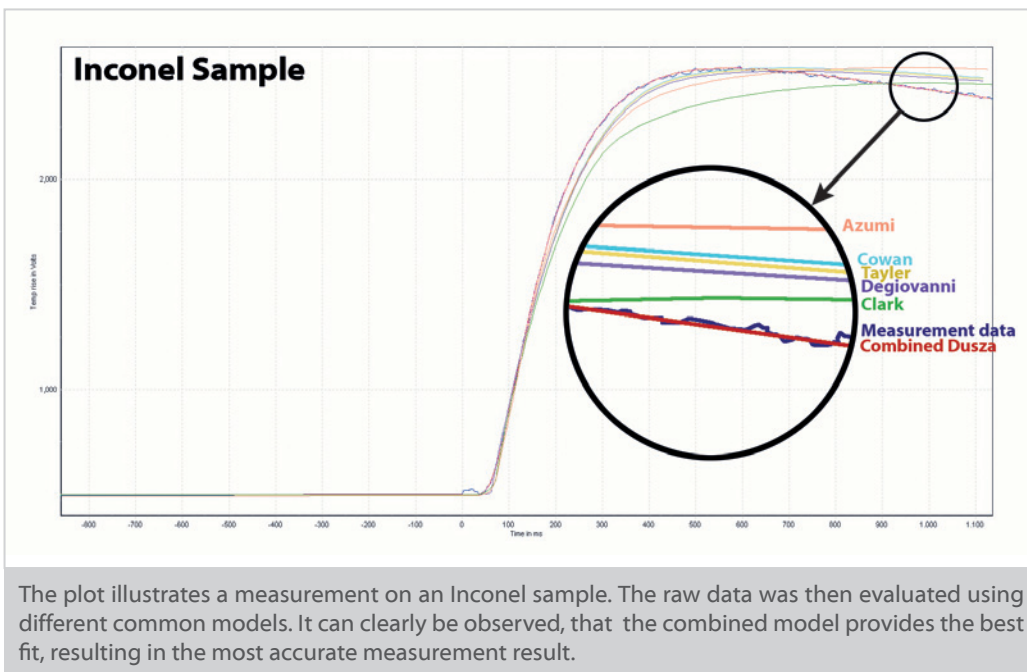

Conclusion

The combined model method with nonlinear parameter estimation has been proven for more than 100 samples. In all cases it worked reliably and its results gave the correct adiabatic, finite pulse, and/or heat loss corrected values. The

two main advantages of the method are that no operator choice between the different models and correction is necessary, and the fit can be checked by plotting the model curve.

Low Thermal Conductive PMMA

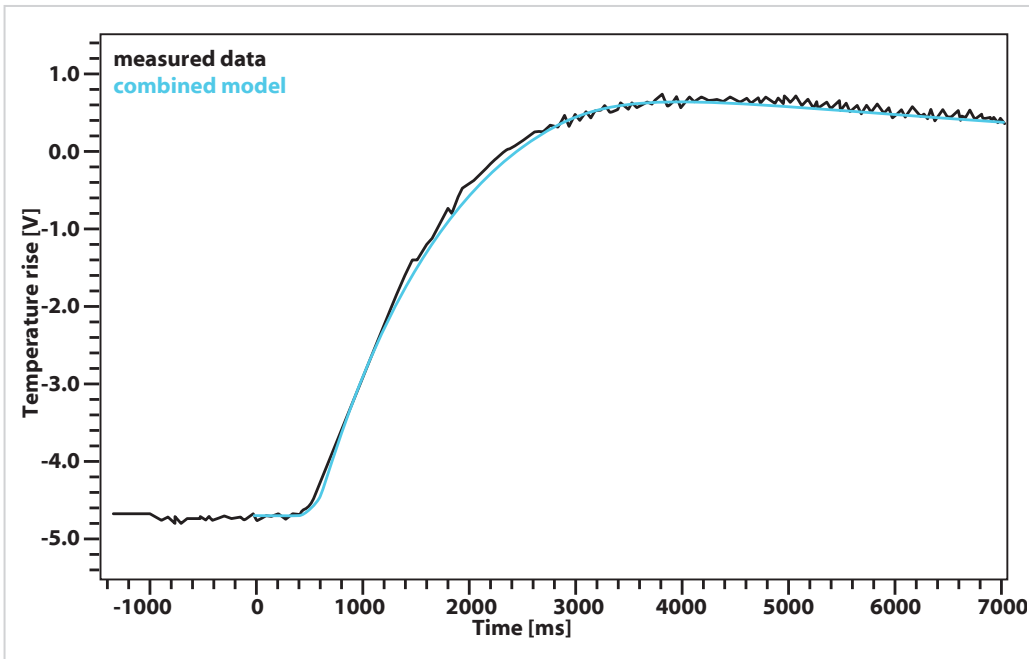

Temperature rise of the PMMA sample (length 1.01 mm, half maximum time 1218.75 ms). The combined model illustrates a perfect fit to the data points.

High Thermal Conductive Graphite

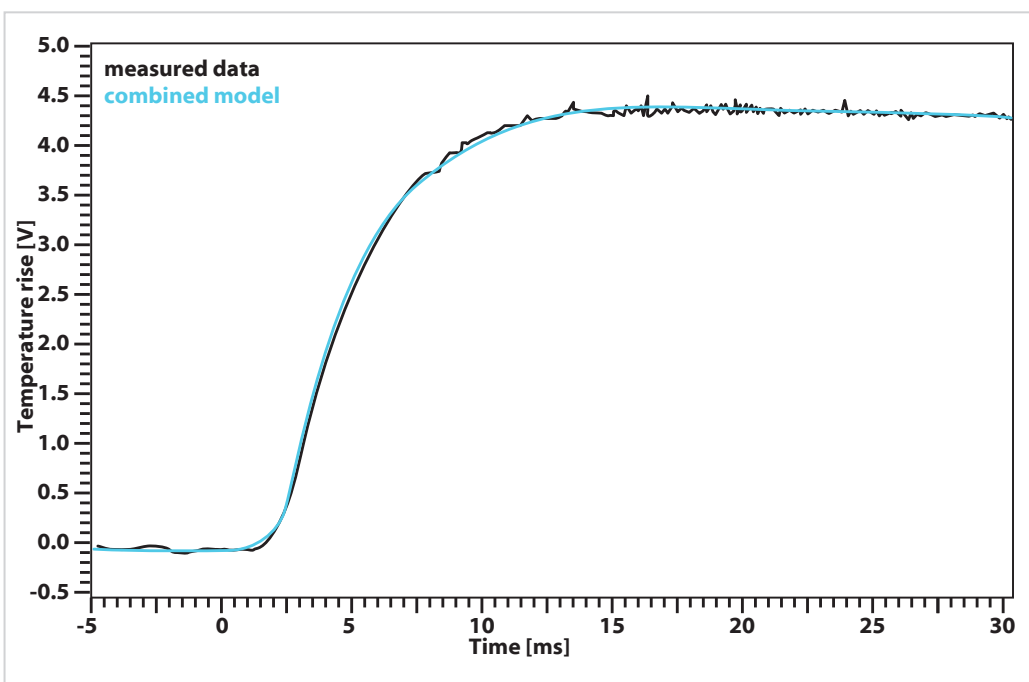

Temperature rise of an graphite sample (length 1.11 mm, half maximum time 4.37 ms). The combined model curve is fitted to the data points.

MODIFIED COMBINED MODEL / SPECIAL MODEL FOR TRANSLUCENT SAMPLES

Standard Heat Loss Model

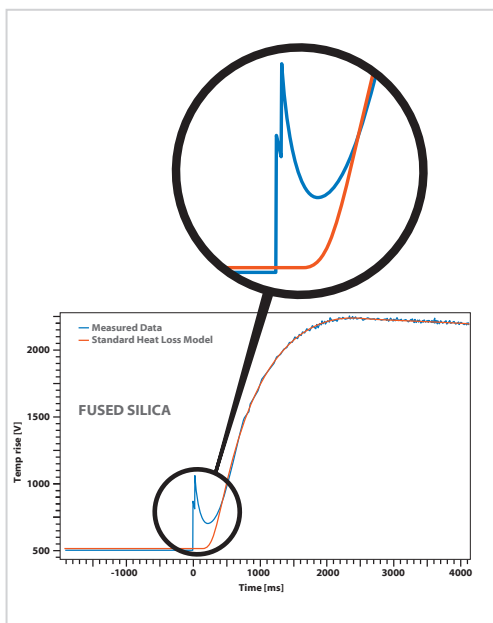

Modified Combined Model

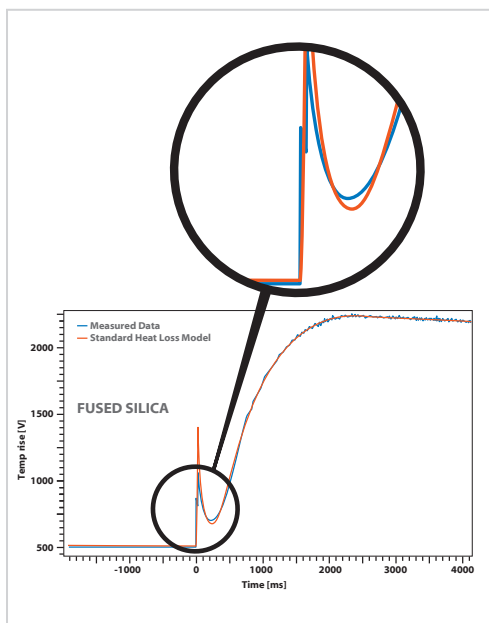

As illustrated in the graph, the temperature rise for translucent samples, generated by the induced energy pulse, results in an immediate signal increase of the detector. This initial signal has to be considered and corrected, as it distorts the measurement result to a seemingly higher thermal diffusivity. Up to now, existing

models could not provide a sufficiently good fit for this immediate temperature rise phenomena. Our unique combined model enables the correction of the sample data and provides an adjusted fit, leading to significantly improved measurement results.

TECHNICAL DATA

	LFA 500 LT/500/1000/1250
Temperature range	-100/-50 up to 500°C RT up to 500 / 1000 / 1250°C Boost function up to 1450°C (limited furnace lifetime)
Heating rate	0.01 up to 100 K/min
Thermal Diffusivity	0.01 up to 2000 mm ² /s
Thermal Conductivity	0.1 up to 4000 W/(m·K)
Accuracy	Thermal diffusivity ± 2.4% Specific Heat ± 5%
Repeatability	Thermal diffusivity ± 1.9% Specific Heat ± 3%
Flash source	Light flash 15 J/pulse variable pulse energy: software controlled Pulse width: 20 up to 2000 µs
Vision control (for LFA 500/1250)	Perfect field of view
IR-detector	InSb: RT up to 1350°C MCT: -100 up to 500°C
Atmosphere	inert, oxidizing, reducing, vacuum
Vacuum	up to 10 ⁻⁵ mbar
Data aquisition	2 MHz
Gas control	manual or MFC gas dosing systems
Sample holders	for round, square, powders, pastes, laminates, samples and mechanic pressure
Sample size	∅3mm / 6mm / 8mm / 10mm / 12.7mm / 25.4mm 6x6mm / 10x10mm / 20x20mm (from thin film up to 6mm height)
Sample numbers	up to 18 samples up to 5 samples (LFA 500/1250)

APPLICATIONS

Thermal conductivity, thermal diffusivity and specific heat capacity of glass ceramics

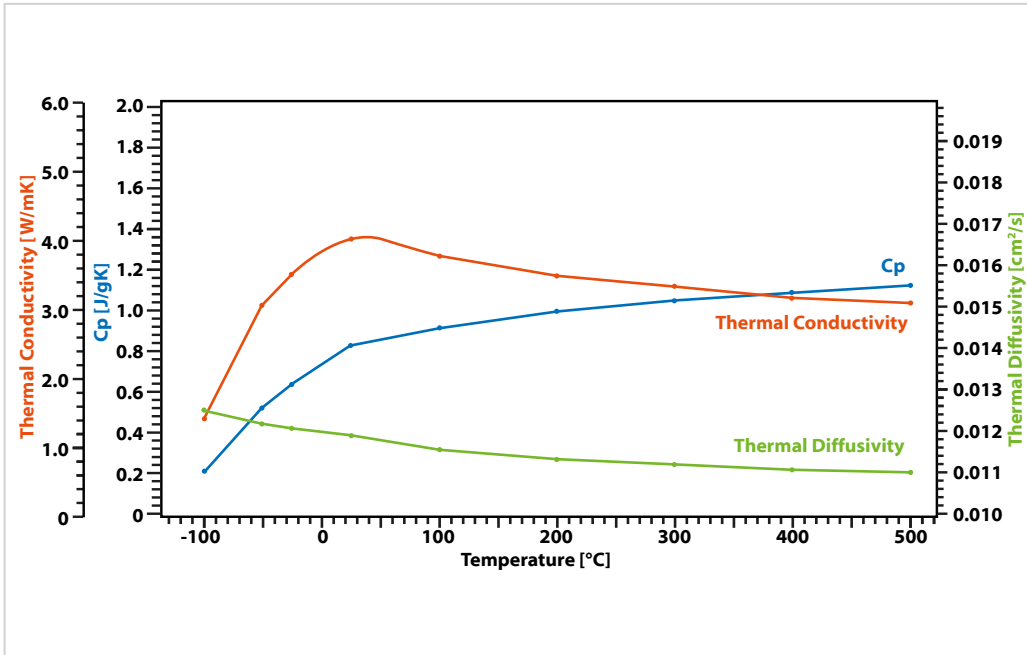

BCR 724, a standard glass ceramic has been measured using LFA 1000. Therefore, a small disc of 1 mm thickness and 25 mm diameter was cut out of a plate of bulk material and coated with graphite for the measurement. The LFA 500 gives the thermal diffusivity as a direct function of temperature. The Cp data was obtained in a comparative way by measuring a known ceramic standard under the same conditions in a second sample position of the same sample holder. Using this, the thermal conductivity was calculated out of the product of density, specific heat and thermal diffusivity. The result shows a slightly decreasing thermal diffusivity and conductivity while the Cp value increases over temperature.

Thermal conductivity of graphite

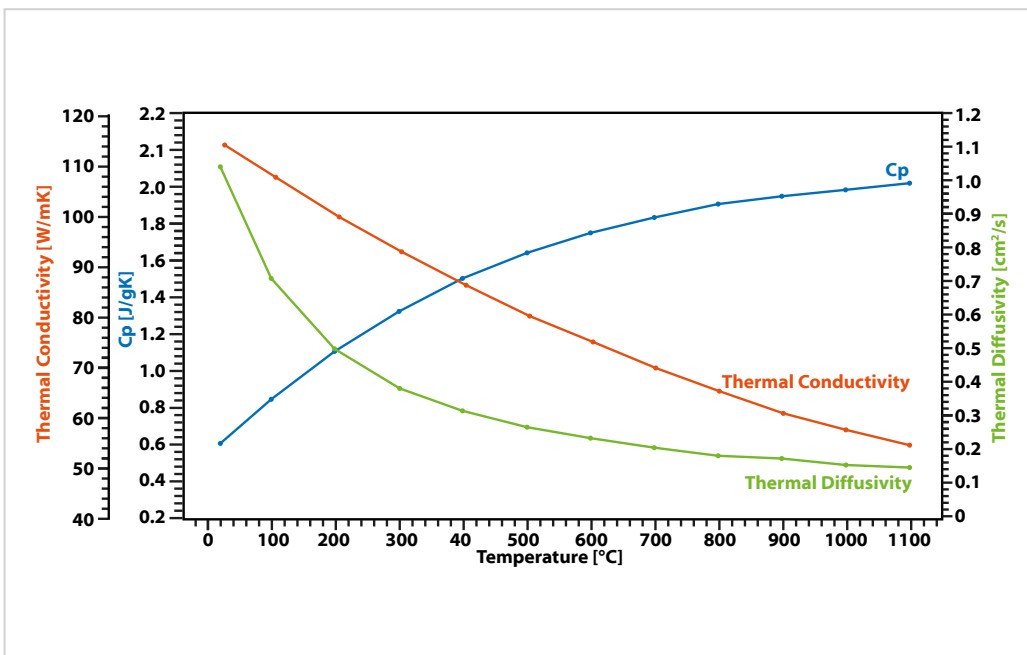

A graphite sample has been investigated using the LFA 500. Thermal diffusivity has been determined directly at several temperature between RT and 1100°C. Specific heat capacity has been determined using a known graphite standard in a second sample position as a reference in the same measurement. The product out of diffusivity, specific heat and density gives the corresponding thermal conductivity. The result shows a linear decreasing thermal conductivity which is typical and a thermal diffusivity that is showing a plateau above 500°C. The Cp is slightly increasing over temperature.

Thermal diffusivity of glass ceramic

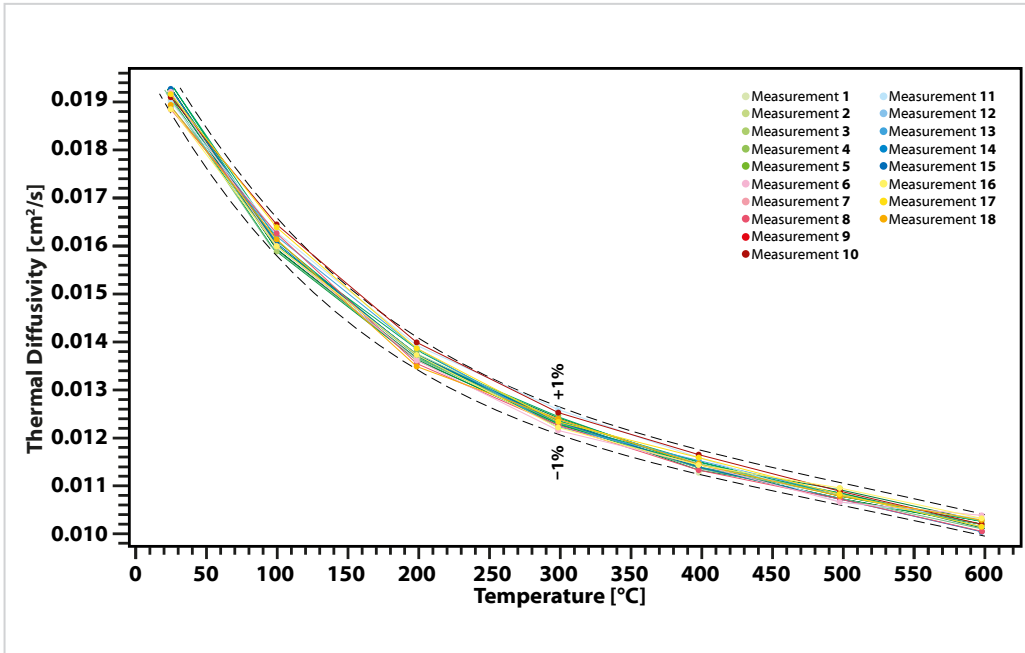

Pyroceram, a glass ceramic trademark of Corning used as a standard material in various applications, has been measured using the LFA 500 to show the reproducibility of thermal diffusivity values. In total 18 measurements were performed with 18 samples that were cut out of one bulk block. Each sample was measured separately and the result shows a spread in the result that is in a range of $\pm 1\%$ in a temperature range up to 600°C.

Influence of sample thickness on thermal conductivity accuracy of LFA 500

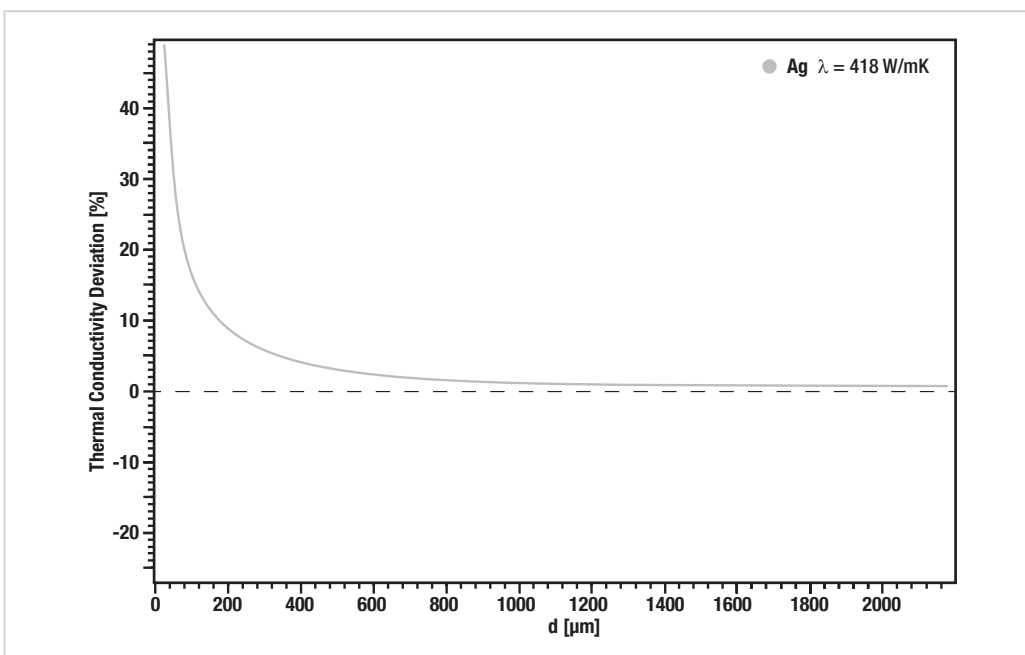

The accuracy of thermal conductivity values depending on sample thickness was investigated using a silver standard.

To get an idea which sample thickness is ideal for the laser flash method, silver samples with different thickness were measured at room temperature. The thermal conductivity was calculated out of thermal diffusivity, density and heat capacity. The scheme shows that the accuracy (deviation from literature value) grows exponential the smaller the diameter gets. The limit for an accurate value is around 200 micrometers. Below that "barrier" the values are dramatically different. However this is not only because of the limitations of the method, but also due to the fact that thin layers show different behavior like bulk materials what can be investigated using the THIN FILM LFA or other thin film techniques.

**LINSEIS GmbH Germany**

Vielitzerstr. 43

95100 Selb

Tel.: (+49) 9287 880 0

E-mail: info@linseis.de

**LINSEIS Inc. USA**

109 North Gold Drive

Robbinsville, NJ 08691

Tel.: (+1) 609 223 2070

E-mail: info@linseis.de

**LINSEIS China**

Kaige Scientific Park 2653 Hunan Road

201315 Shanghai

Tel.: (+86) 21 5055 0642

Tel.: (+86) 10 6223 7812

E-mail: info@linseis.de

**LINSEIS France**

2A Chemin des Eglantines

69580 Sathonay Village

Tel.: (+33) 6.24.72.33.31

E-mail: contact@ribori-instrumentation.com

**LINSEIS Poland**

ul. Dabrowskiego 1

05-800 Pruszków

Tel.: (+48) 692 773 795

E-mail: info@linseis.de

www.linseis.com**Products:** DIL, TG, STA, DSC, HDSC, DTA, TMA, MS/FTIR, In-Situ EGA, Laser Flash, Seebeck Effect, Thin Film Analyzer, Hall-Effect**Services:** Service Lab, Calibration Service

10/19

LINSEIS